



Americans with Disabilities Act

ADA CHECKLIST FOR POLLING PLACES



June 2016

Part 1 discusses polling place accessibility with a focus on the areas of a facility that may be used as a polling place on Election Day.

Part 2 includes a list of the tools election officials will need in order to use the Checklist, some helpful tips on taking measurements and photographs, and a useful list of the most common tools for temporary remedies and the circumstances in which they may be used.

Part 3 is the 2016 Checklist.

Reproduction of this document is encouraged. Additional copies of this publication may be obtained, viewed or downloaded from the technical assistance section of the ADA Website (www.ada.gov) or by calling the ADA Information Line at 800-514-0301 (voice), 800-514-0383 (TTY).

TABLE OF CONTENTS

Polling Place Accessibility is Required by the Americans with Disabilities Act	1
Requirements for Accessibility	2
Evaluating the Physical Accessibility of Polling Places	2
Getting Started	3
Parking	3
Passenger Drop-off Locations	5
Accessible Routes	5
Ramps	7
Protruding Objects	8
Building Entrance	9
Lifts and Elevators	11
Voting Area	11
Tools for Surveys	12
Tools and Documentation	12
Completing Measurements and Recording Information	12
Taking Photographs	14
Temporary Remedies	14
Polling Place Accessibility Checklist	16

POLLING PLACE ACCESSIBILITY IS REQUIRED BY THE AMERICANS WITH DISABILITIES ACT

The Americans with Disabilities Act (ADA) is a federal civil rights law that provides protections to people with disabilities to ensure that they are treated equally in all aspects of life. Title II of the ADA requires state and local governments (“public entities”) to ensure that people with disabilities have a full and equal opportunity to vote. The ADA’s provisions apply to all aspects of voting, including polling places (or vote centers). Voting at one’s polling place allows voters the chance to interact with neighbors and candidates who talk with voters outside the polling place, and to ask questions of or receive assistance from trained poll workers inside the polling place. Simply put, voting in person at a local polling place is the quintessential American voting experience.

In communities large and small, people cast their ballots in a variety of facilities that temporarily serve as polling places, such as libraries, schools, and fire stations, or churches, stores, and other private buildings. Voters include people with a variety of disabilities, such as those who use wheelchairs, scooters, or other devices, those who have difficulty walking or using stairs, or those who are blind or have vision loss. They are people, young and old, who have come to their polling place to exercise their right to vote. Many public entities report that their polling places are accessible. However, the Government Accountability Office estimates that only 27% of polling places were accessible to people with disabilities in the 2008 elections.¹ This means that 73% of the polling places used in 2008 had architectural barriers that made it difficult or even impossible for people with disabilities to enter their polling place and vote side by side with their neighbors.

People with disabilities must have the opportunity to be full participants in an integrated civic event. The ADA requires that public entities ensure that people with disabilities can access and use all of their voting facilities. Because

a mix of public and private facilities are used as polling places, public entities may ensure Election Day accessibility of a polling place by using low-cost temporary measures, such as portable ramps or door stops, rather than necessarily making permanent modifications to a facility. If temporary measures will not fix a barrier, and public entities are unable to make a permanent modification to fix the barrier, then the public entity must look for an alternative, accessible polling place. In some circumstances, when a public entity is unable to identify or create an accessible polling place for a particular voting precinct or ward, election administrators may instead use an alternative method of voting at the polling place.² Public entities are encouraged to make permanent modifications to their facilities used as polling places, such as

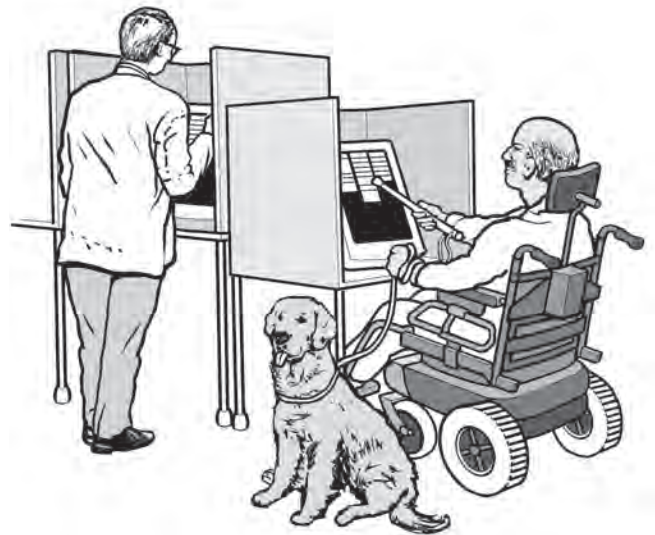

A voter with a disability casting his ballot

schools, community centers, and town halls. The use of temporary measures to provide access to polling places on Election Day does not change a public entity’s obligations under the ADA to ensure that its programs and services are accessible to people with disabilities, nor does it mean that a temporary remedy would be appropriate in a public facility on an everyday basis.

REQUIREMENTS FOR ACCESSIBILITY

The ADA's regulations and the ADA Standards for Accessible Design set out what makes a facility accessible and should be used to determine the accessibility of any facility being considered for use as a polling place. This publication, the ADA Checklist for Polling Places (2016 Checklist), provides guidance to election officials for determining whether a polling place already has the basic accessibility features needed by most voters with disabilities or can be made accessible on Election Day using temporary solutions to remove barriers. The updated Checklist includes provisions from the 2010 ADA Standards for Accessible Design ("2010 Standards").³ Any alterations made to a polling place must comply with the 2010 Standards.

Other Justice Department Publications

In addition to the 2016 Checklist, election officials should consult the Department's 7-page publication on the rights of voters with disabilities, *The Americans with Disabilities Act and Other Federal Laws Protecting the Rights of Voters with Disabilities*.

Another Justice Department publication, *Solutions for Five Common ADA Access Problems at Polling Places*, illustrates suggested temporary solutions for several common accessibility problems found at polling places.

This 2016 Checklist and other Justice Department publications, as well as the title II regulation and the 2010 Standards are available at www.ada.gov.

Part 1: Evaluating the Physical Accessibility of Polling Places

The 2016 Checklist, found in Part 3 of this document, is designed to assist officials in determining whether a facility being considered for use as a polling place is accessible to people with mobility or vision disabilities, and, if not, whether modifications can be made to ensure accessibility or relocation to another accessible facility will be necessary. The 2016 Checklist should be used to evaluate both new and existing polling places. Completing the 2016 Checklist will provide guidance on whether a facility is accessible for voters with disabilities, and how to identify and remedy any barriers that exist.



Accessible polling place

¹U.S. Government Accountability Office Report: Voters with Disabilities; Additional Monitoring of Polling Places Could Further Improve Accessibility; September 2009.

²See U.S. Department of Justice Technical Assistance: "The Americans with Disabilities Act and Other Federal Laws Protecting the Rights of Voters with Disabilities," (September 2014), available at www.ada.gov.

³The requirements that new construction and alterations comply with the 2010 Standards went into effect on March 15, 2012. Facilities that were built or altered before that date, and that complied with the 1991 Standards, need not be modified

to comply with the 2010 Standards as to those provisions included in the 1991 Standards. See 28 C.F.R. §35.151(b)(2)(i). This is referred to as a safe harbor. The 1991 Standards and the 2010 Standards, as applied to polling places, are very similar, however, with the exception of the requirements for accessible parking. For example, the 1991 Standards required only one van-accessible space for every eight accessible spaces, see 28 C.F.R. pt. 36, Appendix D, §4.1.2(5)(b), while the 2010 Standards require one van-accessible space for every six accessible spaces, see 2010 Standards §208.2.4.

Getting Started

Individuals using the 2016 Checklist need not be experienced in evaluating facilities for accessibility. It is designed to be used to evaluate key areas that must be accessible. By following these directions, staff can identify accessible polling places and consider how to implement temporary and permanent accessibility remedies to those facilities found to be inaccessible. References are also provided to the 2010 Standards for more information about particular requirements. We encourage election officials to provide training to their staff on compliance with the ADA.

An evaluation of polling place accessibility focuses on those areas of a facility that may be used as a polling place on Election Day. Think about how people generally arrive at, enter, and move through the polling place. Do people drive and park? Are people dropped off at the entrance? Do they arrive on foot or do they take public transportation? This document addresses the following key areas or features that must be accessible: the parking area and passenger drop-off sites; routes (both exterior and interior); the entrance to the polling place; and the voting area itself.

Arriving at the Polling Place

Parking

If parking is provided for voters, accessible parking must be provided for people with disabilities. An accessible space is composed of three elements: the parking space, an access aisle adjacent to the space that is wide enough to allow voters with a mobility disability to get out of their car or van, and signage designating it as an accessible space. The 2010 Standards require one accessible parking space per 25 parking spaces provided (up to the first 100 spaces). One of six (or fraction of six) accessible parking spaces, but always at least one, must be van accessible. Generally, the access aisle must be at least 60 inches wide for cars and 96 inches wide for vans. Van accessible spaces can also have an access aisle at least 60 inches wide if the width of the van parking space is at least 132 inches. A sign, with the International Symbol of Accessibility, must mark each accessible parking space. Van accessible spaces must be designated as such on the sign at these spaces. Accessible parking spaces and the access aisles serving them must be on a surface that is stable, firm, and slip resistant (e.g., clear of gravel or mud) without wide cracks or broken pavement and located on the closest accessible route to the accessible entrance. The accessible parking spaces and access aisles must also be level

to allow a safe transfer from the car to a person's wheelchair. (See Part 2 of this document for tips on measuring slopes and cross slopes.)

Parking requirements are in Section A of the 2016 Checklist found in Part 3 of this document.

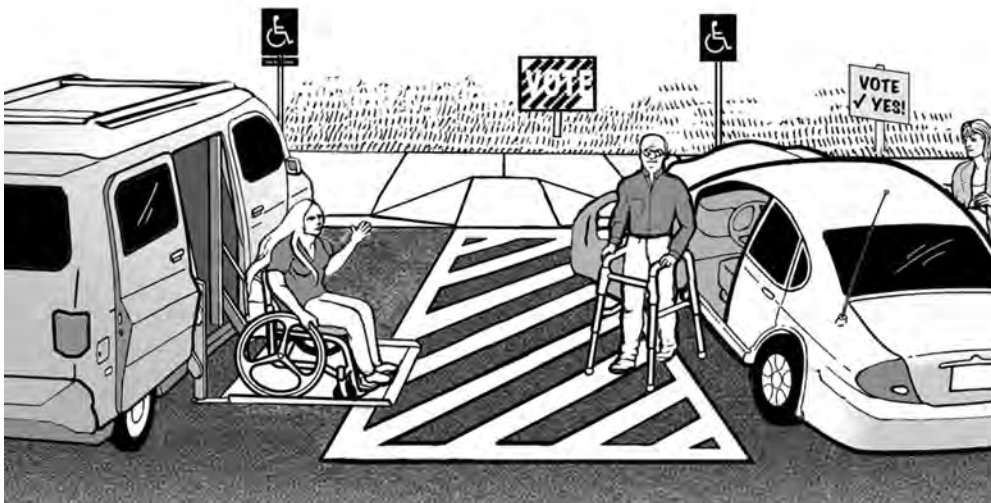

A van accessible parking space and a car parking space share an access aisle

Solutions for Accessibility: Problems Involving the Parking Area

Problem One: Parking is available, but no accessible parking is provided or there are not enough accessible parking or van accessible spaces.

Solution: Find a relatively level parking area near the accessible entrance and then designate the area for accessible parking spaces and adjacent access aisles. Use three parking spaces to make two accessible parking spaces with an access aisle. Traffic cones or other temporary elements may be used to mark these spaces and access aisles. Provide a temporary sign designating each accessible parking space and make sure the access aisle of each space is connected to the accessible route to the accessible entrance.

Problem Two: Accessible parking is provided, but it does not have a marked access aisle next to each designated accessible parking space.

Solution: Use traffic cones to mark and block off the access aisle and curb ramp area. The first accessible parking space provided should be a van accessible parking space with an access aisle that is at least 96 inches wide.

Problem Three: Accessible parking spaces or access aisles are on a sloped surface and do not provide a level area for a safe transition from the voter's car to a wheelchair.

Solution: Find a parking area that is close to the accessible entrance and is level. Provide accessible parking spaces and access aisles in that area by marking them off with traffic cones. Make sure the accessible parking spaces connect to an accessible route to the entrance. Provide a sign designating each accessible

parking space. When the parking area generally is not level, you may need to look beyond the parking area, to driveways and streets, for example, to provide accessible parking in a level area temporarily on Election Day.

Problem Four: No sign with the International Symbol of Accessibility is installed at each accessible parking space.

Solution: Provide a temporary sign in front of each accessible parking space, including a "van accessible" sign for the van parking space.

Problem Five: A large number of accessible parking spaces are provided, including van accessible spaces, at a school near the main building entrance. The voting area and entrance to the voting area, however, are at the rear of the school and there are no designated accessible parking spaces in this area.

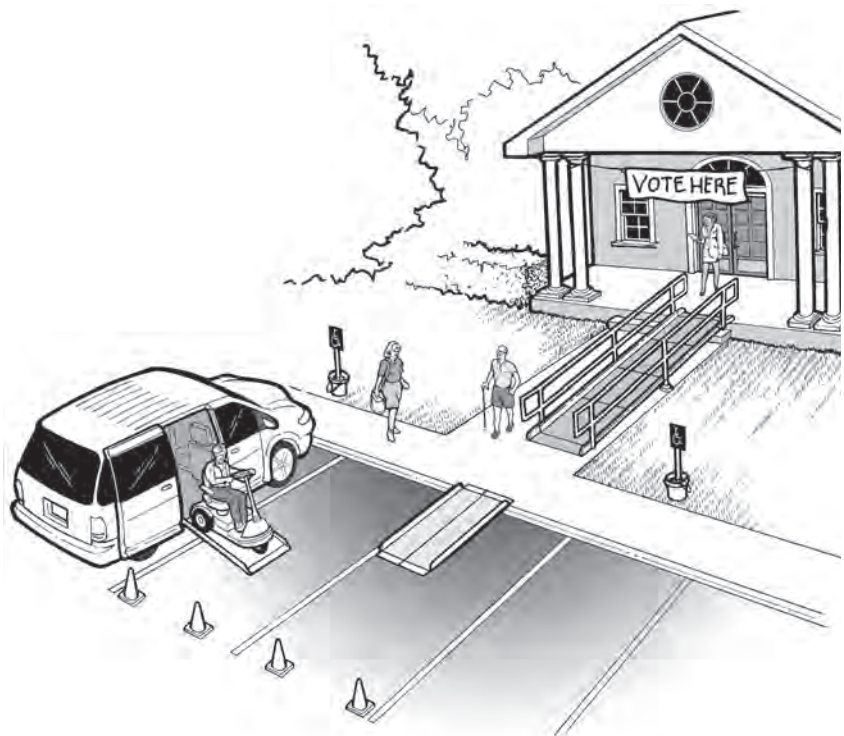

Three standard parking spaces are converted into a van accessible parking space with an access aisle. Cones mark and block off the access aisle and a temporary curb ramp with edge protection connects to an accessible route to the polling place.

Solution: Find a relatively level parking area near the accessible entrance to the voting area and then designate the area for accessible parking spaces and adjacent access aisles. Traffic cones or other temporary elements may be used to mark the spaces and access aisles. Provide a temporary sign for each accessible parking space and make sure the access aisle of each space is connected to the accessible route to the accessible entrance.

Passenger Drop-off Locations

Some voters with disabilities will be driven to the polling place and dropped off in a passenger drop-off area near the entrance. If the polling place is served by passenger drop-off areas, then at least one drop-off area must be accessible. An accessible drop-off area, also known as an accessible passenger loading zone, must have a level access aisle next to the vehicle space. If a curb separates the access aisle from an accessible route, a curb ramp must be provided so that people with disabilities can get to the accessible route leading to the accessible entrance.

Passenger drop-off area requirements are in Section B of the 2016 Checklist found in Part 3 of this document.

Accessible Routes (Exterior and Interior)

Once a voter with a disability arrives at the polling site, there must be an accessible route from the accessible parking, passenger drop-off sites, sidewalks and walkways, and public transportation stops to get to the entrance of the voting facility. The accessible route must be at least 36 inches wide. It may narrow briefly to 32 inches wide, but only for a distance of up to 24 inches. (See Part 2 of this document for tips on taking measurements.) Whenever possible, the accessible route must be the same as or near the general circulation path (i.e., the path for general pedestrian use).

Inside the polling place, there must be an accessible route from the entrance through hallways, corridors, and interior rooms leading to the voting area. The route must be free of abrupt changes in level, steps, high thresholds, or steeply sloped walkways. The accessible route is essential for people who have difficulty walking or who use wheelchairs or other mobility devices to get into the polling place and to the voting area. Where an accessible route is different from the general circulation path, signs will be needed to direct voters with disabilities to the accessible route and to the voting area.

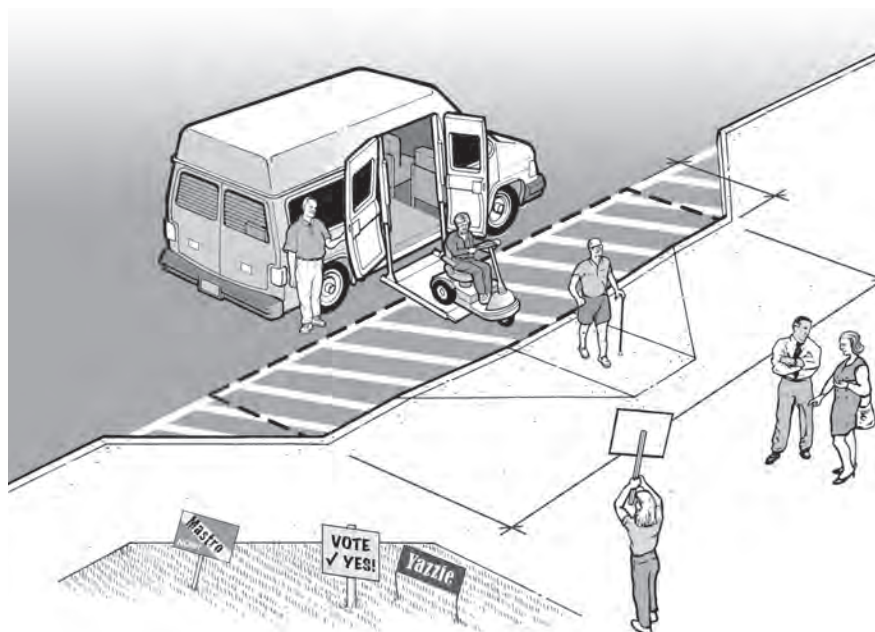

Route requirements are in Sections C and E of the 2016 Checklist found in Part 3 of this document.



Accessible routes to and within the polling place

**Solutions for Accessibility:
Problems Involving the Accessible Route**

Problem One: The sidewalk connecting parking to the polling place entrance is too steep to be accessible.

Solution: Check to see if there is another sidewalk that provides an accessible route to the accessible entrance. Sometimes there is a less direct route that can serve as the accessible route. If no accessible route can be found from the current designated accessible parking, relocate the accessible parking using traffic cones and signs to an area where there is an accessible route to the entrance.

Problem Two: The accessible route crosses a curb and no curb ramp is provided.

Solution: Install a portable ramp.

Problem Three: One or two steps are part of the route leading to the accessible entrance.

Solution: Install a portable ramp.

Problem Four: The interior hallway leading to the voting area contains a set of stairs that cannot be ramped.

Solution: If the accessible route cannot be relocated, look for another area where voting may be provided. For example, if the stage in a school auditorium used for voting is up several steps, perhaps the hallway or lobby area may be accessible and used for voting instead of the stage. Or, if a church basement located down a flight of stairs is used as the voting area, perhaps one of the ground floor rooms could be used as the voting area. If it is impossible to relocate the voting area for all voters, find a location for an accessible voting station that offers the same privacy as the other voting area.

Ramps

If any part of the accessible route - exterior or interior - has a slope greater than 1:20, it is considered a ramp and must meet the requirements for ramps. (See Part 2 of this document for tips on measuring running slopes and cross slopes.) If any part of the accessible route contains steps, it must be ramped. Even one short step at an entrance or in a hallway can prevent access by a person using a wheelchair, walker, or cane and can make entry difficult for many people who have other mobility disabilities. Interior and exterior ramps must not be too steep and must have a level landing at the bottom and top, and where the ramp changes direction. They must meet the ADA's requirements regarding slope, width, landings, handrails, and edge protection. Ramps with a rise greater than six inches must have handrails and if there are vertical drop offs on the sides, there must be edge protection.

In the past, at some polling places where one or more steps were present, officials or other voters have carried people using wheelchairs up the steps. This practice is not only dangerous for the person being carried, but also for those lifting the wheelchair. It is also degrading to the person using a wheelchair and does not provide independent access. Carrying should never be used as an alternative to providing an accessible way to enter a polling place (or other facility).

Ramp requirements are in Section G of the 2016 Checklist found in Part 3 of this document.

Solutions for Accessibility: Problems Involving Ramps

Problem One: There is a six inch high step on the accessible route that has a ramp that is only three feet long, making the ramp too steep and, therefore, inaccessible.

Solution: Alter the route to avoid the steep ramp or place a temporary ramp that is at least six feet long over the short ramp.

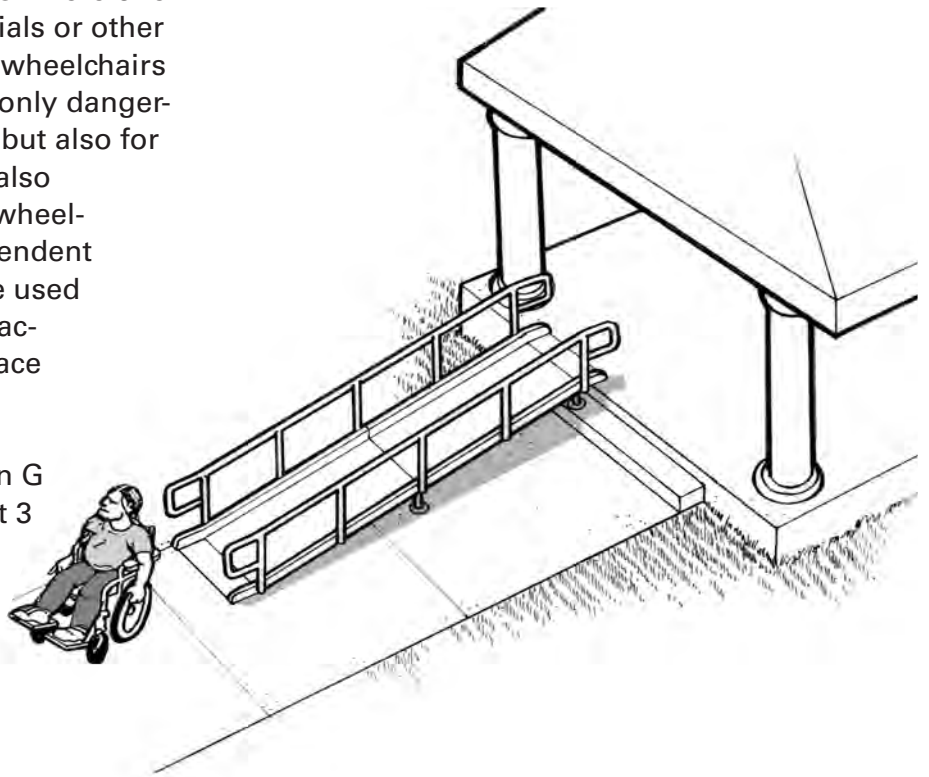

A portable ramp with edge protection and handrails is placed over stairs to provide an accessible route on Election Day.

Protruding Objects

When people who are blind or who have vision loss use a cane to detect hazards, only objects located at 27 inches above the floor or ground or lower are detectable. If an object is higher than 27 inches and wall-mounted, it must not protrude more than four inches into the path of travel. Similarly, post-mounted objects higher than 27 inches must not protrude more than 12 inches into the path of travel. There must be at least 80 inches clear height above the pedestrian route. To make a protruding object detectable: place an object or a barrier, such as a traffic cone, below the protruding object in the cane-detectable area not more than 27 inches above the floor. The undersides of stairs in any route must be enclosed or protected with a cane-detectable barrier, so that people who are blind or have vision loss will not hit their heads on the underside.

Protruding objects are found outdoors on sidewalks and walkways, and indoors in lobby areas, hallways, or voting areas. Because people who are blind or have vision loss may walk on any circulation path, not just the accessible routes, all routes serving or leading to the voting area must be checked for protruding objects.

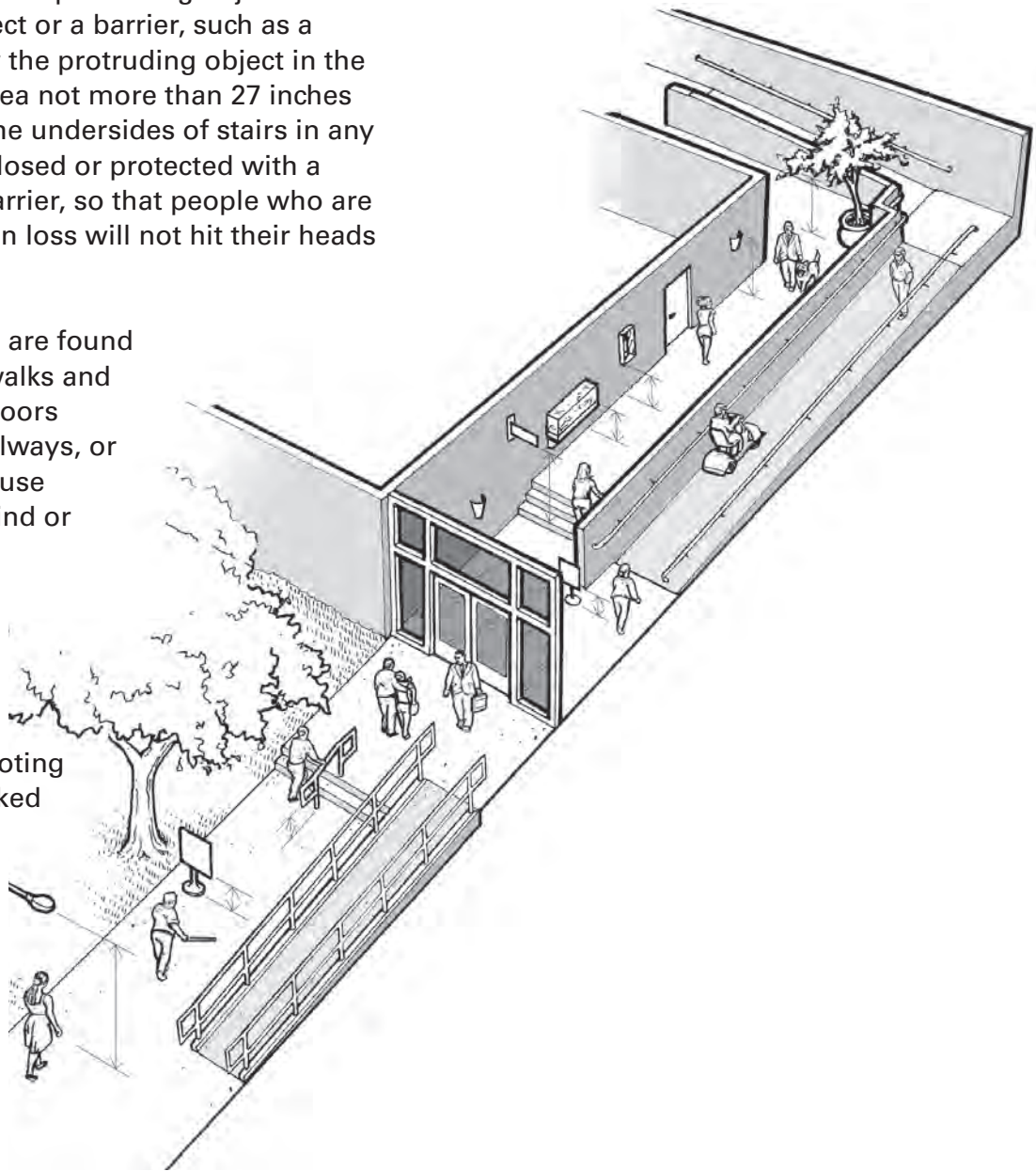

Examples of outdoor protruding objects include post or wall-mounted signs and low-hanging tree limbs. Examples of indoor protruding objects include fire extinguishers and wall-mounted display cases, wall sconces, open staircases, exit signs, overhead signs, banners, and some arched doorways.

Protruding object requirements are in Sections C, E, and F of the 2016 Checklist found in Part 3 of this document.

Signs or other objects in the pedestrian route can be a hazard if the bottom is more than 27 inches but less than 80 inches above the route. Objects that overhang the pedestrian route must be at least 80 inches above the route.

Solutions for Accessibility: Problems Involving Protruding Objects

Problem One: Objects, such as branches and ceiling-mounted televisions, over a route are lower than 80 inches above the ground or floor.

Solution: Prune the branches or remove the items that are hanging below 80 inches. Another approach is to install a detectable barrier under the item that is too low. The detectable barrier or object must be no higher than 27 inches above the route.

Problem Two: A wall-mounted display case protrudes seven inches from the wall and the bottom of the case is 40 inches above the floor.

Solution: Place a detectable object or skirting below the case. The bottom of the skirting or detectable object must be no higher than 27 inches above the floor.

Problem Three: The bottom of a set of stairs is open and voters who are blind or have vision loss can hit their head on the underside of the stairs.

Solution: Provide a detectable fence or other object so voters cannot walk under the stairs.

Building Entrance

A polling place must have at least one accessible entrance. At least one door at the accessible entrance must have a minimum clear width of 32 inches for a voter who uses a wheelchair or other mobility device to pass through the doorway. (See Part 2 of this document for tips on taking measurements.) Door hardware must be useable with one hand without tight grasping, pinching, or twisting of the wrist, so that it is operable by someone with limited mobility in their hands. Doors may not have high thresholds that impede voters who use wheelchairs or other mobility devices in crossing the threshold. Inaccessible entrances must have signs directing voters to the accessible entrance. The accessible entrance must remain



When the underside of a set of stairs is open, it is a hazard to people who are blind or have low vision. Enclosing the area below the stair or installing a cane-detectable barrier helps the person to stop before hitting her head.

unlocked at all times the polling place is open.

Building entrance requirements are in Section D of the 2016 Checklist found in Part 3 of this document.

Solutions for Accessibility: Problems Involving the Building Entrance

Problem One: One or two steps at the entrance prevent access.

Solution: If another entrance is accessible and on an accessible route from parking, passenger drop-off sites, or public transportation stops, designate it as the accessible entrance. If the main entrance is not accessible, install a directional sign at the main entrance directing voters with disabilities to the accessible entrance. Keep the accessible entrance unlocked during all voting hours. If another accessible entrance is not available, install a temporary ramp at the main entrance.

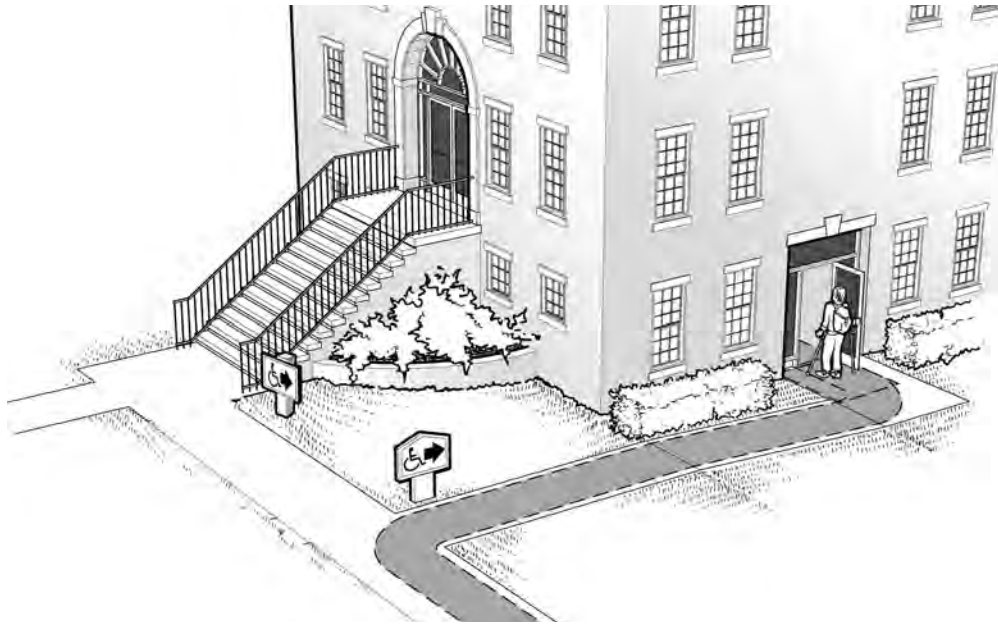

Accessible entrance to polling place with signs directing voters to the accessible entrance

Problem Two: The entrance door threshold is one inch high.

Solution: Short ramps or wedges may be used on both sides of the threshold to allow a voter in a wheelchair to pass over the threshold.

Problem Three: The entrance doors are narrow double leaf doors that are normally opened by an automatic door opener but it is not working on Election Day.

Solution: Keep both doors propped open, station volunteers near the doors to open them for voters while the polling place is open, or provide a temporary doorbell to notify officials

that the door needs to be opened in a timely manner.

Problem Four: The entrance door has a door knob and/or latch that requires tight pinching and twisting and is not accessible.

Solution: There are four typical solutions: add an accessible pull or handle and leave the door unlatched; install fully accessible door hardware; leave the door propped open; or provide a temporary doorbell to notify officials that the door needs to be opened in a timely manner.

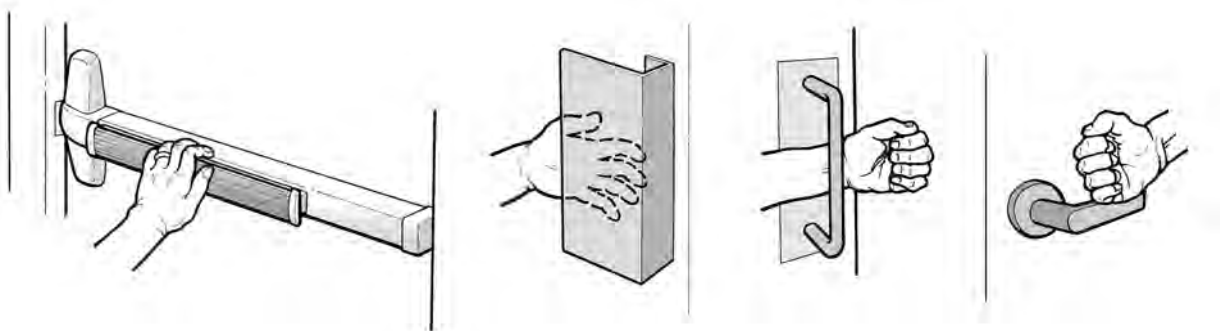

Examples of accessible door hardware

Lifts and Elevators

If the voting area is not on the same level as the entrance, there must be an independently operable elevator or lift to provide an accessible route to individuals with disabilities. The door into the elevator or lift and the space within must be wide enough to accommodate wheelchairs and other mobility devices. All controls should be operable without tight grasping, pinching, or twisting and should be no higher than 48 inches. Chair or seated lifts found on staircases do not comply with the 2010 Standards as they are not suited for many voters with disabilities, including people who use wheelchairs.

Lift and elevator requirements are in Section H and I of the 2016 Checklist found in Part 3 of this document.

Solutions for Accessibility: Problems Involving Lifts and Elevators

Problem One: The elevator or lift to the voting area requires a key to be inserted before the elevator or lift is operational.

Solution: Relocate the voting area to avoid use of the elevator or lift. Otherwise, leave the key in the elevator or lift for the entire time the polling place is open, or station a volunteer, who has been trained in its operation, to operate the elevator or lift while the polling place is open.

Voting Area

The accessible voting area must have an accessible entrance and adequate circulation and maneuvering space for voters who use wheelchairs or scooters, or who walk with mobility devices, to get in to the voting area, sign in at the check-in table, and go to the voting stations or machines. Within the voting area there must be enough clearance for an individual with a disability to access and use all the voting equipment. Voting machines should be positioned so that the highest operable part is no higher than 48 inches. If voters are expected to vote at counters or tables, there should be a writing surface that provides knee and toe clearance so that a voter who uses a wheelchair may sit at and use the counter or table.

Voting area requirements are in Section F of the 2016 Checklist found in Part 3 of this document.

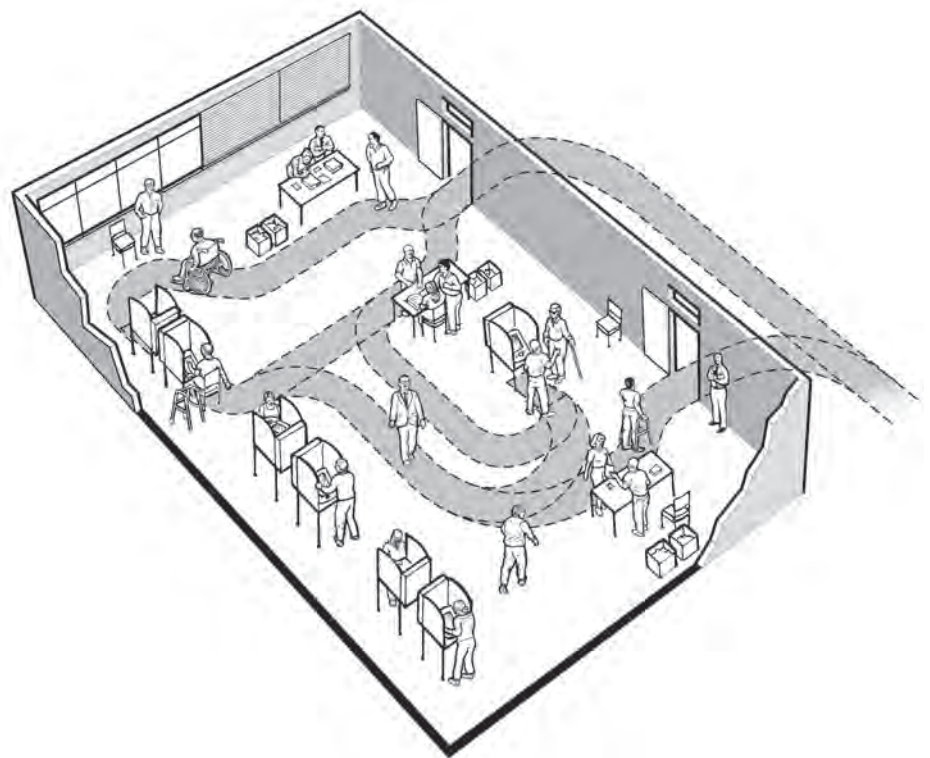

An accessible route connects the building entrance with the voting area, including voter check-in and voting stations.

Solutions for Accessibility: Problems Involving the Voting Area

Problem One: The voting area is in a small room and the accessible voting machine is only two feet from the check-in table.

Solution: Relocate the voting area to a larger space such as a hallway or lobby or change the layout of the voting area by moving the check-in table outside the room to provide appropriate space for voters with disabilities to use the accessible voting machine.

Part 2: Tools for Surveys

The tools necessary to conduct surveys using the 2016 Checklist are inexpensive and many, if not all, can be purchased at local hardware and home improvement stores.

Tools and Documentation

The following tools are needed for the 2016 Checklist:

- a metal tape measure at least 20 feet long
- a digital level or a bubble level that is at least 24 inches long
- a door pressure gauge
- a digital camera with a flash
- a copy of the 2016 Checklist for each location to be surveyed
- a clipboard and pens or pencils

Completing Measurements and Recording Information

One person can complete a survey of a polling place but it is often quicker and easier for two people to work together. One can be responsible for taking the measurements and the other for recording the information and taking any photographs.

Taking Measurements

Sloped Surfaces

Measuring the slope of a ramp, parking space, pedestrian route, or other ground or floor surface is important to identify whether the surface is accessible. Two slope measurements perpendicular to one another should be taken at each location. One is the running slope that runs parallel to the direction of travel and the other is the cross slope, which runs perpendicular to the running slope.

The amount of slope or grade is described as the proportion of a vertical rise to a horizontal length. It is usually described as:

- a ratio (e.g., 1:20, means one unit of vertical rise for each 20 units of horizontal length); or
- a percentage (e.g., 8.33% which equates to a ratio of 1:12 or 4.76 degrees).

The easiest way to measure slope is to use a digital level. The digital display gives a reading that may be shown as a ratio, percent, or degree. Calibrate the digital level before each use.



A digital level that can be used with measurements in degrees, percentages, or ratios

Another way to measure slope is to use a 24 inch level with leveling bubbles and a tape measure. Place the level on the sloped surface in the direction you wish to measure. Rest one end of the level at the highest point of the sloped surface and lift the other end (see image) until the bubble is in the middle of the tube. This is the "level" position. While the level is in this position, measure the distance between the bottom end of the level and the sloped surface below. If the distance is two inches or less, then the slope is 1:12 or less. When the distance is more than two inches, record the distance on the checklist so the exact slope can be calculated later. For measuring cross slope, if the distance measured from the level position is ½ inch or less then the slope is 1:48 or less.

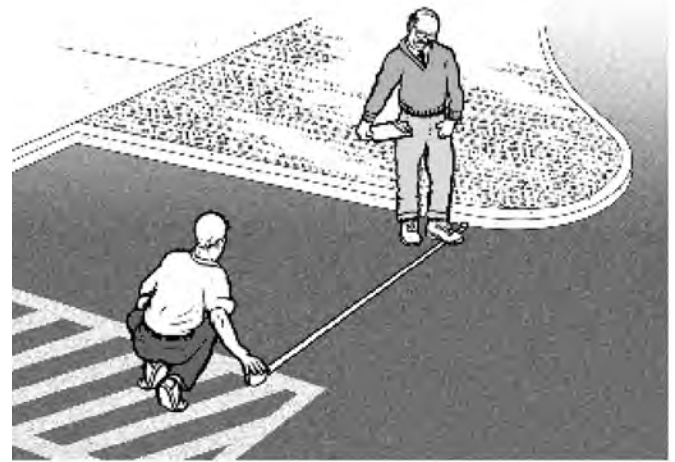

Using a tape measure to measure the width of a parking space



Measuring slope using a 24 inch bubble level and tape measure

Using the Tape Measure

A tape measure is used to measure the length, width, height, and depth of various elements including parking spaces and access aisles, routes, thresholds, doorways, and protruding objects.

Measuring Door Openings

Special care is needed when measuring the clear opening of a doorway. To measure the clear opening of a standard hinged door, open the door to 90 degrees. Measure the clear door opening from the edge of the doorstop to the edge of the door (not to the door jamb). This measures the clear width of the door opening through which people pass, which is less than the width of the door itself. Door handles and push bars should not be included in the measurements of door opening widths.

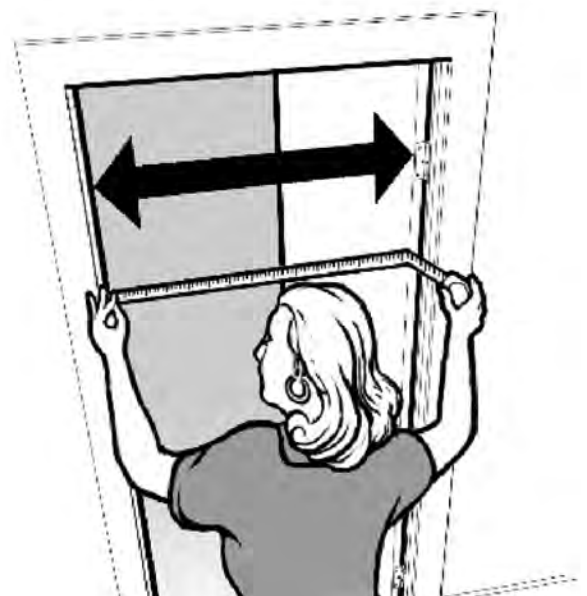

Measuring the clear door opening

Taking Photographs

It is always useful to first take a photo that will clearly identify the site, then the elements surveyed. A comprehensive set of photographs makes it easier to understand existing conditions after the survey is completed. It is a good idea to take several photos of the exterior and interior of the polling place. We recommend taking photographs of measurements and non-compliant elements such as steps. It is likely that others may review information about the facility you are surveying.

Temporary Remedies

Many accessibility barriers at polling places can be removed with temporary remedies. Although not designed to be permanent solutions, the following tools can be used to provide remedies on Election Day to improve accessibility. These tools can often be found in local hardware and home improvement stores or online at minimal cost.

Temporary Remedies

Traffic Cones

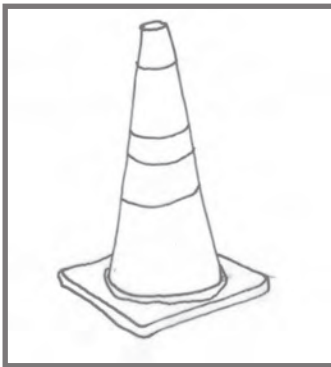

Traffic cones can be used to mark parking spaces, access aisles and passenger loading zones, to hold parking signs, and to warn of protruding objects.

Van Parking Sign



Van accessible parking signs should be used to designate van accessible parking locations.

Parking Signs

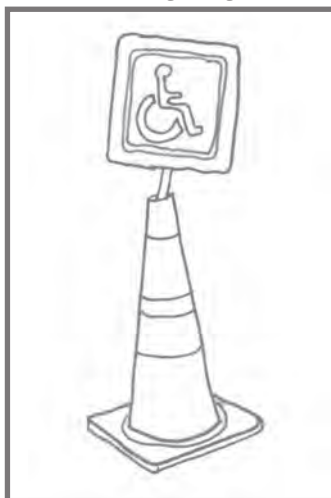

Accessible parking signs should be used to designate accessible parking locations.

Directional Signs



Directional signage should be used to show direction to the accessible route, accessible entrance, and voting area.

**Portable ramp -
step six inches or less**

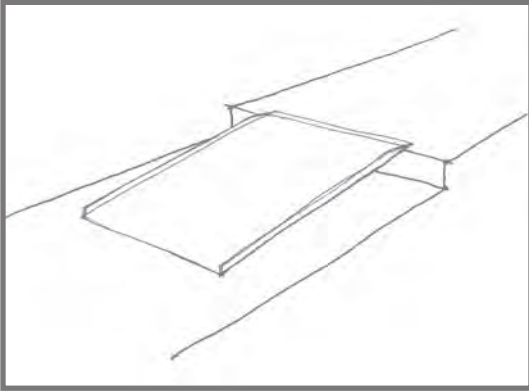

Portable ramps without handrails can only be used for heights six inches or less and can provide access at a curb or low step. Portable ramps also can be placed flat to cover holes or gaps in a sidewalk.

**Portable ramp -
greater than six inch step**

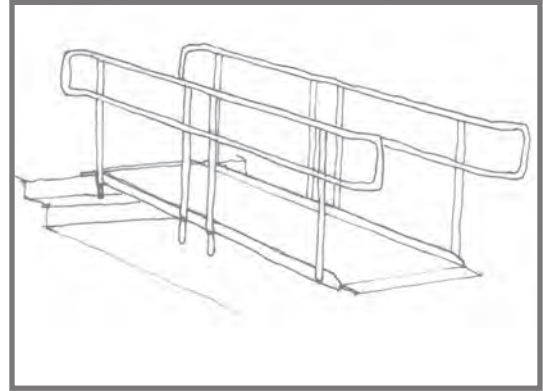

Portable ramps with handrails must be used for heights greater than six inches to provide access over steps. For ramps greater than six inches high, temporary edge protection such as a pipe or piece of wood can be attached with ties or twine to the edges of the ramp. Edge protection must run the entire length of the ramp.

**Remove post (increase clear width
at double leaf doors)**

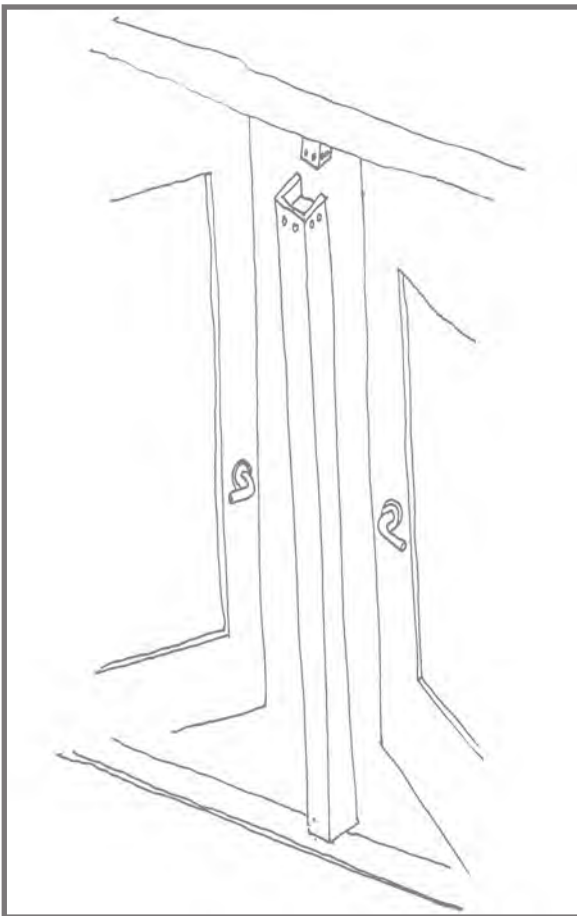

Remove center post between doors if the post is bolted to the door frame to provide a 32 inch clear opening or to allow double doors to be propped open.

Door stop

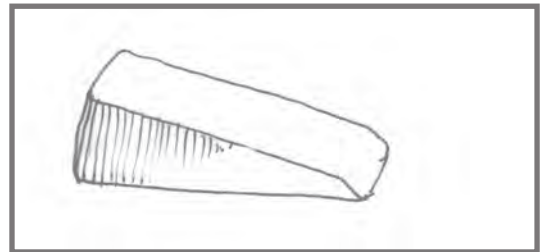

Door stops can be used to prop open a door if the door handle is inaccessible, or if there is an inadequate maneuvering clearance for a person using a wheelchair or other mobility device to open the door.

Wedges

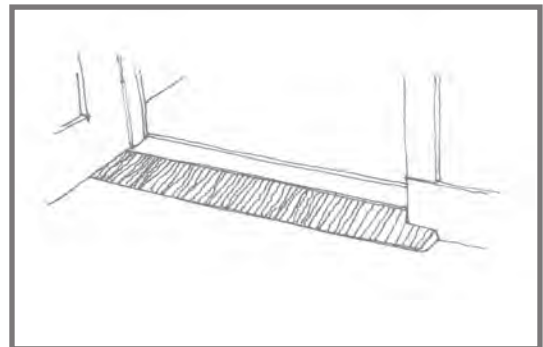

Wedges can provide access at thresholds and slight changes in level.

Part 3 : Polling Place Accessibility Checklist

Ward: _____ Precinct: _____ Staff: _____ Date: _____ Time: _____

Address: _____ Location name: _____

This checklist is designed to provide guidance for determining whether a polling place has basic accessibility features needed by voters with disabilities.

For each question below there are citations to the 2010 ADA Standards for Accessible Design (2010 Standards). Please review the 2010 Standards for all requirements.

There are some differences between the 1991 ADA Standards for Accessible Design (1991 Standards) and the 2010 Standards. Elements and spaces in a building constructed or altered before March 15, 2012, that complied with the 1991 Standards may remain in compliance with the 2010 Standards. See 28 C.F.R. §35.150(b)(2) for more information.

In completing the checklist, provide a measurement for every question with a “no” answer. Where a question asks about more than one element, provide a note in the comments explaining any noncompliant elements.

Status of Polling Place

All Elements Compliant

Non-Compliant Elements Remediable with Temporary Measures

Non-Compliant Elements Not Remediable with Temporary Measures
(Relocate Polling Place)

Ward: _____ Precinct: _____ Staff: _____ Date: _____ Time: _____

Address: _____ Location name: _____

A	Parking Only complete this section if off-street parking is provided to voters. If off-street parking is not provided to voters, go to Section B. If more than 25 parking spaces are provided to voters, see the 2010 Standards for the number of accessible parking spaces required. (§208.2)	Yes	No	N/A	Comments/ Remedies
A1	Is there at least one designated van accessible space with signage with the International Symbol of Accessibility and designated "van accessible"? (§§208.2, 208.2.4, 502.6)				
A2	Are the designated van accessible spaces at least 96" wide with a 96" wide access aisle, or 132" wide with a 60" wide access aisle? (§§502.2, 502.3) Width of space _____ Width of access aisle _____				
A3	For van accessible spaces (particularly in a garage or parking structure), is there vertical clearance of at least 98" for the vehicular route to the parking space, in the parking space and access aisle, and along the vehicular route to the exit? (§502.5)				
A4	Are designated accessible parking spaces and the access aisles serving them on a level surface, with slopes not exceeding 1:48 in all directions? (Note: Curb ramps may not be part of an access aisle since they include slopes greater than 1:48.) (§502.4)				
A5	Are the surfaces of the designated accessible parking spaces and access aisles stable, firm, and slip resistant? (§§502.4, 302.1)				
A6	Are the designated accessible parking spaces located on the shortest accessible route to the accessible entrance? (§208.3.1)				

Ward:_____ Precinct:_____ Staff:_____ Date:_____ Time:_____

Address:_____ Location name:_____

B	Passenger Drop-Off Area Only complete this section if a passenger drop-off area is provided for voters. If a drop-off area is not provided to voters, go to Section C.	Yes	No	N/A	Comments/ Remedies
B1	Is the vehicle pull-up space on a level surface, with slopes not exceeding 1:48 in all directions? (§503.4)				
B2	Is the access aisle next to the vehicle pull-up space on a level surface, with a slope not exceeding 1:48 in all directions? (§503.4)				
B3	Is there vertical clearance of at least 114" (9 feet 6 inches) from the site entrance to the vehicle pull-up area, in the access aisle, and along the vehicular route to the exit? (§503.5)				
B4	Is a curb ramp provided if a curb separates the access aisle from the accessible route to the accessible entrance? (§§206.2.1, 503.3)				
B5	Is the width of the curb ramp surface at least 36" (not counting the side flares)? (§405.5)				
B6	Does an accessible route connect the access aisle and curb ramp to the accessible entrance of the polling place? (§206.2)				

Ward: _____ Precinct: _____ Staff: _____ Date: _____ Time: _____

Address: _____ Location name: _____

C	Exterior Route to Accessible Entrance Complete a separate Exterior Route form, when applicable, for the routes from 1) parking, 2) passenger drop-off areas, 3) public sidewalks and 4) public transportation stops. Exterior route location: _____	Yes	No	N/A	Comments/ Remedies
C1	Is the route at least 36" wide? (§403.5.1)				
C2	Is the route free of abrupt changes in level greater than ½", including stairs? (§303)				
C3	Is the route free of surface openings greater than ½", such as grates or holes in the pavement? (§302.3)				
C4	Are walking surfaces stable, firm, and slip resistant? (§302.1)				
C5	Is the route free of wall mounted objects that protrude more than 4" into the path of travel and are between 27" and 80" high? (§307.2)				
C6	Is the route free of post mounted objects that protrude more than 12" into the path of travel and are between 27" and 80" high? (§307.3)				
C7	Are objects that hang over the pedestrian route 80" or higher, including the underside of exterior stairs? (§307.4)				
C8	If the route crosses a curb, is there a curb ramp that is at least 36" wide with a slope no more than 1:12? (§§303.4, 405.2, 405.5, 406.1)				
C9	Is the running slope of part of the route greater than 1:20? If yes, go to Section G. (§402.2)				
C10	Is the cross slope of the accessible route no greater than 1:48? (§§403.3, 405.3)				

Ward: _____ Precinct: _____ Staff: _____ Date: _____ Time: _____

Address: _____ Location name: _____

D	Polling Place Entrances	Yes	No	N/A	Comments/ Remedies
D1	Is the clear width of the door opening (one door or one active leaf of a double door) at least 32"? (§404.2.3)				
D2	Is each door hardware useable with one hand without tight grasping, pinching, or twisting of the wrist? (§§309.4, 404.2.7)				
D3	On the pull side of the door, is there at least 18" of clearance provided to the side of the latch? (§404.2.4)				
D4	Is the area in front of the door level, with slopes no greater than 1:48 in all directions? (§§404.2.4.4, 405.7.1)				
D5	If there are doors in a series, is the distance between the two hinged doors at least 48" plus the width of the door swinging into the space? (§404.2.6)				
D6	Can the second door (interior door) in the series be opened with no more than 5 pounds of force? (§309.4)				
D7	Does the second door (interior door) in the series comply with D2, D3, and D4, above?				
D8	Are door thresholds no higher than 1/2"? (Note: If the threshold is between 1/4" and 1/2" it must be beveled.) (§404.2.5)				
D9	Do inaccessible entrances have signage directing voters to the accessible entrance? (§216.6)				
D10	If voters are directed to an alternative accessible entrance, is this entrance kept unlocked during voting hours? (28 C.F.R. §§35.130, 35.133)				

Ward: _____ Precinct: _____ Staff: _____ Date: _____ Time: _____

Address: _____ Location name: _____

E	Route from Entrance Into Voting Area	Yes	No	N/A	Comments/ Remedies
E1	Is the route at least 36" wide? (§403.5.1)				
E2	Is the route free of wall mounted objects that protrude more than 4" into the path of travel and are between 27" and 80" high? (§307.2)				
E3	Is the route free of post mounted objects that protrude more than 12" into the path of travel and are between 27" and 80" high? (§307.3)				
E4	Are objects that hang over the route 80" or higher, including the underside of stairs? (§307.4)				
E5	Is the route free of abrupt changes in level greater than 1/2", including stairs? (§303)				
E6	Is the running slope of part of the route greater than 1:20? If yes, go to Section G. (§303.4)				
E7	If the route to the voting area has stairs, is a platform lift or elevator provided? If yes, go to Section H (lifts) or Section I (elevators). (§402.2)				
E8	If doors are provided along the route to the voting area, is the clear width of each door opening (one door or one active leaf of a double door) at least 32"? (§404.2.3)				
E9	Is each door hardware useable with one hand without tight grasping, pinching, or twisting of the wrist? (§§309.4, 404.2.7)				
E10	Can each door be opened with no more than 5 pounds of force? (§309.4)				
E11	Is the threshold at each door no higher than 1/2"? (Note: If the threshold is between 1/4" and 1/2" it must be beveled.) (§404.2.5)				
E12	On the pull side of each door, is there at least 18" of clearance provided to the side of the latch? (§404.2.4)				
E13	Is the area in front of each door level, with slopes no greater than 1:48 in all directions? (§§404.2.4.4, 405.7.1)				

Ward: _____ Precinct: _____ Staff: _____ Date: _____ Time: _____

Address: _____ Location name: _____

F	Within the Voting Area	Yes	No	N/A	Comments/ Remedies
F1	Are floor surfaces stable, firm, and slip resistant? (§302.1)				
F2	Is the route free of wall mounted objects that protrude more than 4" into the path of travel and are between 27" and 80" high? (§307.2)				
F3	Is the route free of post mounted objects that protrude more than 12" into the path of travel and are between 27" and 80" high? (§307.3)				
F4	Are objects that hang over the route 80" or higher, including the underside of stairs? (§307.4)				
F5	Is there enough room to provide a route at least 36" wide to the registration table and voting stations? (§403.5.1)				
F6	Is there enough room to provide a turning space in front of at least one voting station, such as a circle that is at least 60" in diameter? (§304.3)				
F7	Is there enough room to provide a turning space in front of at least one accessible voting machine, such as a circle that is at least 60" in diameter? (§304.3)				

Ward: _____ Precinct: _____ Staff: _____ Date: _____ Time: _____

Address: _____ Location name: _____

G	Ramps Complete a separate ramp form for each ramp, whether exterior or interior. Ramp location: _____	Yes	No	N/A	Comments/ Remedies
G1	Is the running slope of the ramp no greater than 1:12? (§405.2)				
G2	Is the cross slope of the ramp 1:48 or less? (§405.3)				
G3	Is the rise (height) for any ramp run 30" or less? (§405.6)				
G4	Is the ramp, measured between handrails, at least 36" wide? (§405.5)				
G5	Does the ramp have a level landing that is at least 60" long, at the top and bottom of each ramp section? (§405.7)				
G6	For every 30" of rise, is a level landing at least 60" long provided? (§§405.6, 405.7)				
G7	Is a level landing, at least 60" by 60" provided where the ramp changes direction? (§405.7.4)				
G8	If the rise of the ramp is greater than 6", are handrails provided that are between 34" and 38" above the ramp surface? (§§405.8, 505.4)				
G9	If the rise of the ramp is greater than 6" and the ramp or landing has a vertical drop-off on either side of the ramp, is edge protection provided? (§405.9)				

Ward:_____ Precinct:_____ Staff:_____ Date:_____ Time:_____

Address:_____ Location name:_____

H	Lifts	Yes	No	N/A	Comments/ Remedies
H1	Is the lift operational at the time of the survey? (28 C.F.R. §§35.130, 35.133)				
H2	Is the lift independently operable, or can it be made so during Election Day? (§410.1)				
H3	Is there 30" by 48" of clear floor space within the lift? (§§410.3, 305.3)				
H4	Are the controls for the lift no higher than 48"? (§§410.5, 309.3, 308)				
H5	Are the controls useable with one hand without tight grasping, pinching or twisting? (§§410.5, 309.4)				
H6	Is the clear width of the door opening/gate opening at the end of the lift at least 32"? If a side door/gate is provided, is the clear opening width at least 42"? (§410.6)				

Ward: _____ Precinct: _____ Staff: _____ Date: _____ Time: _____

Address: _____ Location name: _____

I	Elevators	Yes	No	N/A	Comments/ Remedies
I1	Is the elevator car door opening at least 36" wide? (§407.3.6, Table 407.4.1)				
I2	Is there space to maneuver within the elevator car, e.g., 51" deep and 68" wide; OR 80" deep and 54" wide; OR 60" deep and 60" wide? (§407.4.1)				
I3	Are hallway elevator call buttons 48" high or lower? (§§407.2.1.1, 308.2, 308.3)				
I4	Are elevator car controls 48" high or lower? (§§407.4.6.1, 308.2, 308.3)				
I5	Does the elevator have visible and audible signals in the hallway to indicate the arrival and direction of the elevator car? (§407.2.2.1)				
I6	Does the elevator have visible and audible signals within the elevator car to indicate the position of the car? (§407.4.8)				

The Americans with Disabilities Act authorizes the Department of Justice (the Department) to provide technical assistance to individuals and entities that have rights or responsibilities under the Act. This document provides informal guidance to assist you in understanding the ADA and the Department's regulations.

This guidance document is not intended to be a final agency action, has no legally binding effect, and may be rescinded or modified in the Department's complete discretion, in accordance with applicable laws. The Department's guidance documents, including this guidance, do not establish legally enforceable responsibilities beyond what is required by the terms of the applicable statutes, regulations, or binding judicial precedent.